

## Get your order *faster.*

With standard material in stock and ready to ship, you get what you need exactly when you need it.

If you have a tight project deadline or just need material quickly, Concept Storage provides fast service you can rely on. Save on lead time, transit time and shipping costs. Concept Storage is local to you.

**Interested?** Contact Concept Storage and get started!

### Tony Attisano

☎ (888) 922.0229 ext: 17  
@ tattisano@conceptstorage.com

📍 **Address**  
1470 Creditstone Rd.  
Vaughan, ON L4K 5W2

## How to Order

### Material Required for Standard Double-Rail Guardrail

- 4x: Double rail column with centered baseplate
- 1x: Double rail column with offset baseplate
- 4x: 10' rail
- 2x: 3' rail
- 2x: 2' rail

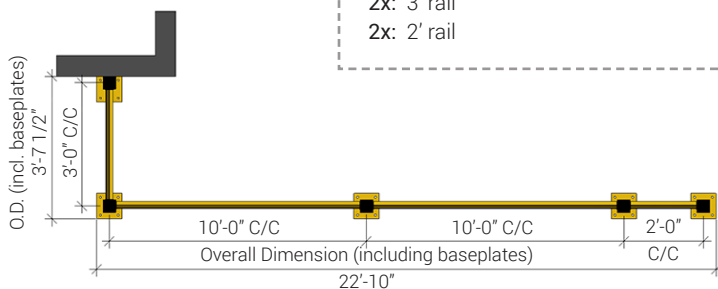

Layout Example (Plan View)

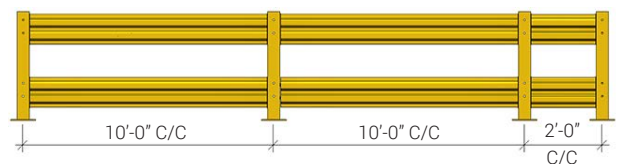

Layout Example (Elevation View)

# Rails

Item Description	Item#
2' Rail (19" exact length)	G-GR2
3' Rail (31" exact length)	G-GR3
4' Rail (43" exact length)	G-GR4
5' Rail (55" exact length)	G-GR5
6' Rail (67" exact length)	G-GR6
7' Rail (79" exact length)	G-GR7
8' Rail (91" exact length)	G-GR8
9' Rail (103" exact length)	G-GR9
10' Rail (115" exact length)	G-GR10

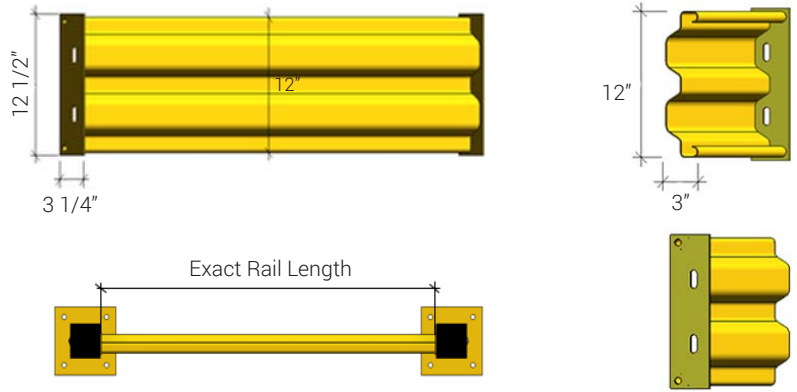

# Columns

Item Description	Item#
Double Rail Column 44" H (5" x 5" column + centered 10" x 10" baseplate)	G-GPDC
Double Rail Column 44" H (5" x 5" column + offset 10" x 10" baseplate)	G-GPDO
Single Rail Column 18" H (5" x 5" column + centered 10" x 10" baseplate)	G-GPSC
Single Rail Column 18" H (5" x 5" column + centered 10" x 10" baseplate)	G-GPSO

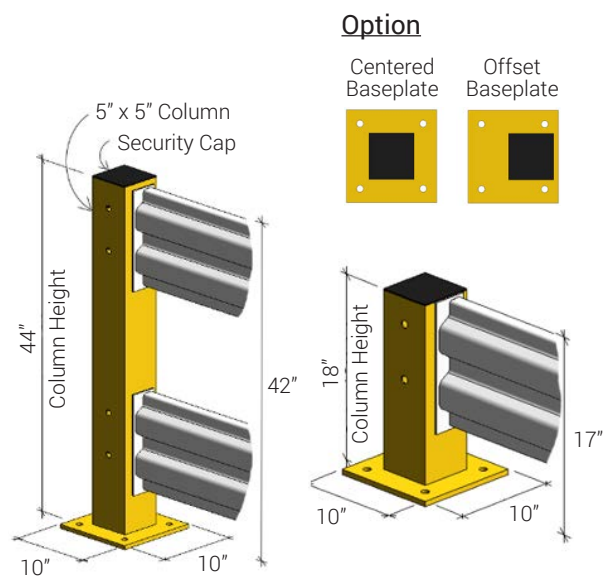

# Anchors & Accessories

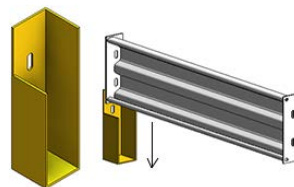

Item Description	Item#
Lift-Out Brackets (sold in pairs)	G-GL1
5/8" x 4 1/2" Floor Anchors (4x/pkg)	G-GFA5

Lift-Out Bracket



Wedge Anchor Bolt  
(sold 4x/pkg)



Finish (all components)   
  
 Safety Yellow

# Bollards

## Item Description

42" H Bollard (4 1/2" diameter + 10" x 10" baseplate)

5/8" x 4 1/2" Floor Anchors (4x/pkg)

## Item#

G-B42

G-GFA1

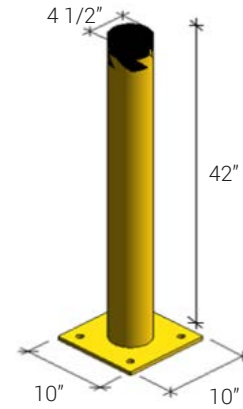

# Self-Closing Safety Gates

## Item Description

Self-Closing Safety Gate - Adjustable from 24" W - 36" W

Self-Closing Safety Gate - Adjustable from 33" W - 48" W

## Item#

G-SG-2436

G-SG-3348

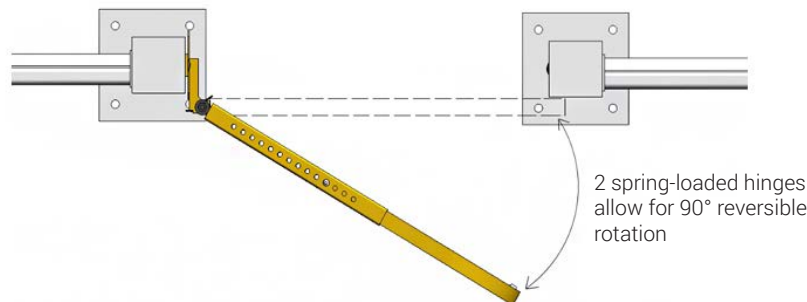
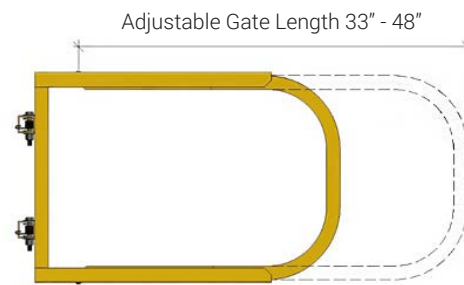
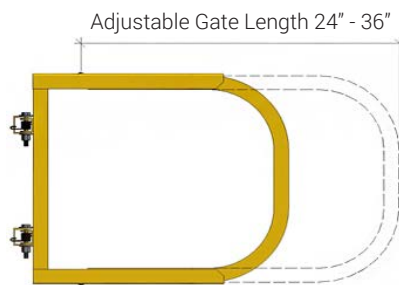

\* Self-closing safety gates are compatible with our heavy-duty guardrail, pedestrian rail and mezzanine systems.

Finish (all components)



Safety Yellow